

Mondial[®] Monobloc

MB64, MB70



Users' Manual

November 2017
Pub. No. 234-3480-06



Read this Manual and Retain
for Future Reference 

Ferno Customer Relations

For ordering assistance or general information:

CANADA AND THE U.S.A.

Telephone (Toll-free)	1.877.733.0911
Telephone	1.937.382.1451
Fax (Toll-free)	1.888.388.1349
Fax	1.937.382.1191
Internet	www.ferno.com

ALL OTHER LOCATIONS

For assistance or information, please contact your Ferno distributor. If you do not have a Ferno distributor, please contact Ferno Customer Relations:

Ferno-Washington, Inc., 70 Weil Way
Wilmington, Ohio 45177-9371, U.S.A.

Telephone	Country Code +1.937.382.1451
Fax	Country Code +1.937.382.6569
Internet	www.ferno.com



USERS' MANUALS
To request additional free users' manuals, contact Ferno Customer Relations, your Ferno distributor, or www.ferno.com.



FERNO Product Name/Model

 Date of Manufacture		(01) Global Trade Item Number
 Serial Number		(11) Date of Manufacture
		(21) Serial Number

 Ferno-Washington Inc. | Wilmington, Ohio 45177 USA | +1.937.382.1451
↑ Manufacturer ↑ GS1 Data Matrix

Disclaimer

This manual contains general instructions for the use, operation and care of this product. The instructions are not all-inclusive. Safe and proper use of this product is solely at the discretion of the user. Safety information is included as a service to the user. All other safety measures taken by the user should be within and under consideration of applicable regulations and local protocol. Training on the proper use of this product must be provided before using this product in an actual situation.

Retain this manual for future reference. Include it with the product in the event of transfer to new users. Additional free copies are available upon request from Customer Relations.

Proprietary Notice

The information disclosed in this manual is the property of Ferno-Washington, Inc., Wilmington, Ohio, USA. Ferno-Washington, Inc. reserves all intellectual property rights, proprietary design rights, manufacturing rights, reproduction use rights, and sales use rights thereto, and to any article disclosed therein except to the extent those rights are expressly granted to others or where not applicable to vendor proprietary parts.

Limited Warranty Statement

The products sold by Ferno are covered by a limited warranty, which is printed on all Ferno invoices. The complete terms and conditions of the limited warranty, and the limitations of liability and disclaimers, are also available upon request by calling Ferno at 1.800.733.3766 or 1.937.382.1451.

UNIQUE DEVICE IDENTITY NOTICE

Ferno complies with the United States Food and Drug Administration's Unique Device Identification regulation to identify medical devices. The UDI label contains information in human- and machine-readable form. Device information is online at the FDA's Global Unique Device Identification Database (GUDID). The public can search and download information at AccessGUDID at www.fda.gov.

The label is located on the main frame on the patient-left side, under the backrest.



Ferno-Washington, Inc.
70 Weil Way
Wilmington, Ohio 45177-9371 U.S.A.
1.937.382.1451



Ferno Washington Italia S.r.l.
via B. Zallone, n. 26, 40066
Pieve di Cento, Bologna, Italy
+39.051.6860028 234-3468-01

TABLE OF CONTENTS

Section	Page	Section	Page
Ferno Customer Relations _____	2	5.11 Intermediate Loading Wheels _____	19
1 - Safety Information _____	4	5.12 Leg Lock (Optional) _____	19
1.1 Warning _____	4	5.13 Telescoping Handles (Optional) _____	20
1.2 Important _____	4	5.14 Telescoping Side Handles (Optional) _____	20
1.3 Tip _____	4	5.15 Smart-Load™ Automatic Leg Release (Loading-End Legs) _____	21
1.4 Bloodborne Disease Notice _____	4	5.16 Smart-Load™ Automatic Leg Release (Control-End Legs, Optional) _____	21
1.5 Fastening System Compatibility _____	4	5.17 Safety-Lock Device (Optional) _____	22
1.6 Symbol Glossary _____	5	5.18 Storage Tray (Optional) _____	22
1.7 Safety and Instruction Labels _____	5	6 - Using the Cot _____	23
2 - Operator Focus _____	6	6.1 Before Placing the Cot in Service _____	23
2.1 Operator Training _____	6	6.2 General Guidelines for Use _____	23
2.2 Operator Height and Strength _____	6	6.3 Changing Cot Positions _____	24
2.3 Terms _____	6	6.4 Transferring the Patient Onto the Cot _____	25
2.4 Using Additional Help _____	7	6.5 Rolling the Cot _____	26
3 - About the Cot _____	8	6.6 Loading the Cot _____	27
3.1 Description _____	8	6.7 Unloading the Cot _____	28
3.2 Compliance _____	9	6.8 Carrying the Cot _____	29
3.3 General Specifications _____	9	6.9 One Operator, Empty Cot _____	29
3.4 Cot Positions _____	10	7 - Maintenance _____	30
4 - Setup _____	11	7.1 Maintenance Schedule _____	30
4.1 Ambulance Information _____	11	7.2 Tracker™ (Optional) _____	30
4.2 Restraints, Pad and Accessories _____	11	7.3 Disinfecting and Cleaning the Restraints _____	30
4.3 Attaching the Leg Restraint _____	12	7.4 Disinfecting and Cleaning the Pad _____	31
4.4 Attaching the Harness _____	12	7.5 Disinfecting the Cot _____	31
5 - Using the Features _____	14	7.6 Cleaning the Cot _____	31
5.1 EZ Pull™ Leg Control Handles _____	14	7.7 Waxing the Cot _____	31
5.2 Leg-Status Indicator _____	14	7.8 Inspecting the Cot _____	31
5.3 Swivel-Lock Release Lever _____	15	7.9 Lubricating the Cot _____	32
5.4 Wheel Locks _____	16	8 - Parts and Service _____	33
5.5 Sidearms _____	16	8.1 U.S.A. and Canada _____	33
5.6 Footrest _____	16	8.2 Worldwide _____	33
5.7 Shock Frame _____	17	8.3 Parts List _____	33
5.8 Backrest _____	18	10 - Accessories _____	34
5.9 Backrest with Extending Headrest (Optional) _____	18	Training Record _____	35
5.10 Backrest with Airway Management Frame (Optional) _____	18	Maintenance Record _____	35

1 - SAFETY INFORMATION

1.1 Warning

Warning notices indicate a potentially hazardous situation which, if not avoided, could result in injury or death.

 **WARNING**

Untrained operators can cause injury or be injured. Permit only trained personnel to operate the cot.

Helpers can cause injury or be injured. Maintain control of the cot, operate the controls, and direct all helpers.

Helpers can be injured. Show helpers where to grasp the cot to avoid pinch points.

Improper use of the cot can cause injury. Use the cot only for the purpose described in this manual.

Attaching improper items to the cot can cause injury. Use only Ferno-approved items on the cot.

Releasing the swivel locks increases the possibility for the cot to tip. Maintain control of the cot at all times.

Improper operation can cause injury. Operate the cot only as described in this manual.

An unattended patient can be injured. Stay with the patient at all times.

An unrestrained patient can fall off the cot and be injured. Use restraints to secure the patient on the cot.

Rolling the cot sideways can cause the cot to tip and injure the patient or operators. Roll the cot only with the head-end or foot-end first.

An unlocked undercarriage can cause injury. Before removing the cot from the ambulance, confirm that both sets of legs unfold completely and lock.

Improper maintenance can cause injury. Maintain the cot only as described in this manual.

Improper parts and service can cause injury. Use only Ferno parts and Ferno-approved service on the cot.

Modifying the cot can cause injury and damage. Use the cot only as designed by Ferno.

Attaching improper items to the cot can cause injury. Use only Ferno-approved items on the cot.

1.2 Important

Important notices emphasize important usage or maintenance information. Failure to follow Important notices could result in damage to the product or property damage.

Important

1.3 Tip

Tips provide recommendations for easier use of the product.

Tip

1.4 Bloodborne Disease Notice

To reduce the risk of exposure to blood or other potentially infectious materials when using the cot, follow the disinfecting and cleaning instructions in this manual.

1.5 Fastening System Compatibility

Combining different manufacturers' products such as a Ferno cot/transport system with a non-Ferno fastening system can increase the user's risk of injury and damage.

Ferno-Washington, Inc. products are designed for use only with Ferno-manufactured fastening systems. Use of a Ferno cot/transport system with a non-Ferno fastening system is misuse of the Ferno product. The user assumes responsibility for the outcome of known, intentional misuse.

1.6 Symbol Glossary

The symbols defined on this page are used on the cot and/or in this manual. Ferno uses symbols recognized by the International Standards Organization (ISO), American National Standards Institute (ANSI) and the emergency medical services industry.



Load Capacity
(Safe Working Load in pounds, kilograms, stone)



Product meets European Union Standards



General Warning of Potential Injury



Pinch Point: Keep Hands Clear



Read the Users' Manual



Operation Requires Two Trained Operators



Unlocked



Locked



Do Not Lubricate



Lubricate



Manufacturer

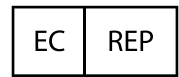

Authorized Representative in the European Community



QR Code (Scan with smartphone to access online material)

1.7 Safety and Instruction Labels

Safety and instruction labels place important information from the users' manual on the cot. Read and follow label instructions. Replace worn or damaged labels immediately.

Pinch Point
(Areas of potential pinch points)
Keep hands clear



Undercarriage Lock Status
(Undercarriage lock mechanisms)



Swivel Lock Release Lever
(Loading-end control panel)



Safety Information
(Control panels)



Leg Lock Lever
(Control-end control panel; when equipped)

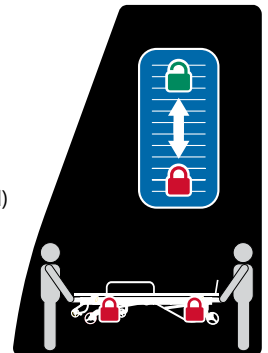

2 - OPERATOR FOCUS

2.1 Operator Training

Operator using the cot:

- must read and understand this manual.
- must have training on proper use of the cot.
- must have training on emergency-medical service and emergency patient-handling procedures.
- must have the physical ability to assist the patient.
- must practice with the cot before using it with a patient.
- must keep training records. For a sample training record sheet, see "Training Record" on page 35.

2.2 Operator Height and Strength

During unloading, the control-end operator must lift and hold the weight of the cot, patient and equipment high enough for the wheels to remain off the ground until the undercarriage legs completely unfold and lock into place.

Supporting this weight requires greater strength from short operators than from tall operators because short operators must raise their arms higher in relation to their shoulders.

If the ambulance is parked on an uneven surface, the control-end operator (and any helpers) may need to lift the cot higher than normal to allow the legs to unfold completely and lock.

Note: Use additional help as needed to lift the weight of the cot, patient and equipment. See "Using Additional Help" on page 7.

2.3 Terms

The following terms are used in this manual.

- **CONTROL END:** The control end of the cot is where the shock frame and footrest are located. This area is also known as the (patient's) foot end of the cot.
- **LOAD:** The load is the overall weight of the patient plus equipment placed on (or attached to) the cot.
- **LOAD CAPACITY:** The load capacity is the amount of weight the cot is designed to hold. This includes the weight of the patient and any accessories attached to the cot such as IV poles, defibrillators, bags, etc.
- **LOADING END:** The loading end of the cot is where the backrest, swivel-wheel control and Safety-Lock Device (if equipped) are located. This area is also known as the (patient's) head end.

WARNING

**Untrained operators can cause injury or be injured.
Permit only trained personnel to operate the cot.**

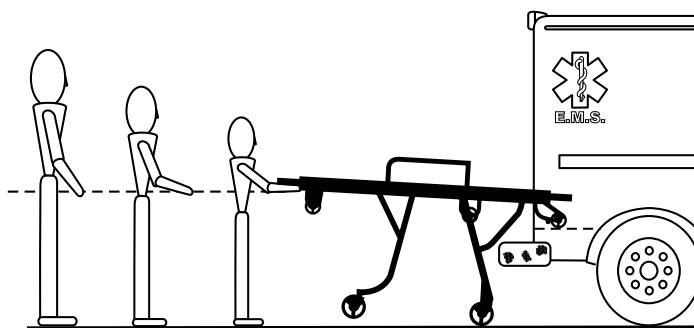

- **OPERATORS:** The trained operators are referred to as the Control-end Operator and Loading-end Operator in this manual. The trained operators maintain control of the cot, operate the controls, and direct helpers.
- **PAD:** The pad is the cushioned surface between the patient and the bed of the cot. It provides patient comfort during transport.
- **ROLLING POSITION:** Roll the cot only in the recommended rolling position. For the Mondial Monobloc, the procedures to load the cot into an ambulance, or unload it from an ambulance, are also accomplished using the rolling position. See "Cot Positions" on page 10.
- **SHEETS:** Sheets or other articles that are placed, or find their way, beneath the patient surface can become caught in the locking mechanism. Tuck sheets between the pad and the patient surface. Keep other articles above the pad.

2.4 Using Additional Help

Operating the cot requires a minimum of two trained operators. They may need additional help when working with heavy loads (patient plus equipment).

- Operators stand at the loading end and control end of the cot, maintain control of the cot, operate the controls, and direct all helpers.
- Side helpers may need to walk sideways under some circumstances. Follow local protocols.
- Ferno recommends that helpers work in pairs to help maintain cot balance.

Refer to the chart for suggested placement for operators and helpers.

Tip

Directing Helpers

Trained operators position themselves at the loading end and control end of the cot and operate the controls. Show helpers where to stand and how to grasp the cot.

WARNING

Helpers can cause injury. Maintain control of the cot, operate the controls, and direct all helpers.

Helpers can be injured. Show helpers where to grasp the cot to avoid pinch points.

Important

Trained operators position themselves at the loading end and control end of the cot and operate the controls. Show helpers where to stand and how to grasp the cot.



Load Capacity

Inspect the cot if the load capacity has been exceeded. See "Inspecting the Cot" on page 31.

Helpers	Changing Levels	Rolling	Loading/Unloading
Two Operators + Two Helpers			
Two Operators + Four Helpers			

Key: O = Operator H = Helper P = Patient

3 - ABOUT THE COT

3.1 Description

The Ferno® Mondial® Monobloc Series Cot (called the cot in this manual) is an emergency patient-handling device designed to transport a patient in a ground-based ambulance.

The cot is for professional use by a minimum of two trained operators. It is designed for roll-in loading to help reduce the risk of back injury to medical service personnel. In this manual, the generic term, "cot" is used when the feature is shared by all models in the series. The individual cot name is used when features differ.

COT FEATURES

- Ergonomic control handles
- Choice of red, green, or silver legs
- Six bed positions and a folded position
- Compatible with Ferno® FL1 and EFX-Lock fasteners
- Loading range Model MB64: 670-730 mm (27-29 in.)
- Loading range Model MB70: 730-790 mm (29-31 in.)
- EZ Pull™ control handles allow operators to operate the control handle first, before assuming the weight of the cot during position changes
- Positive visual feedback when the legs are locked or unlocked using the leg lock indicator
- Control handles not required for raising the cot
- Smart-Load™ Auto-release system (control handle not required to unlock loading-end legs during loading)
- Intermediate loading wheels
- Pneumatic backrest
- 3-Position shock frame with contour feature
- 3-Position swing-down sidearms
- Footrest
- Four 150 mm (6 in.) transport wheels
 - Control-end wheels with wheel locks (two)
 - Loading-end wheels with swivel locks (two)
- Scuff strips w/rollers (optional)
- Set of patient restraints



WARNING

Improper use of the cot can cause injury. Use the cot only for the purpose described in this manual.

OPTIONAL FEATURES

- Smart-Load™ Auto-release system (control handle not required to unlock control-end legs during loading)
- Backrest with extending headrest
- Backrest with airway-management frame
- Leg lock (locks both cot legs in Bed Position 1 or Bed Position 3)
- 4 Telescoping carry handles*
- 2 Side-lifting handles*
- Safety-lock device*
- Storage tray*
- Flat or bolster patient pad*

Note: *Also available separately.

COMPATIBLE FASTENING SYSTEMS

The cot is compatible with the following Ferno® fastening systems:

- Ferno® FL1
- Ferno® EFX-Lock (conversion required, kit available separately)

INCLUDED WITH PURCHASE

The following items are included with purchase:

- Set of 2 patient restraints: one harness torso restraint and one two-piece leg restraint
- Users' manual

3.2 Compliance

MEDICAL DEVICE DIRECTIVE

Ferno products meet the requirements of Medical Device Directive 93/42/EEC as established by the European Union.

CERTIFICATION

The Mondial® Monobloc cot, when used with a Ferno® FL1 or EFX-Lock fastener, meets European Harmonized Standards.

U.S.A. NOTICE

The cot is for use with ambulances that meet the requirements of the "Star of Life" certification via Federal Ambulance Specification KKK-A-1822. For information, contact:

Federal Supply Services, Specifications Section, Suite 8100
470 E. L'Enfant Plaza, SW, Washington, DC 20407



3.3 General Specifications

Specifications for the cot are shown in the tables at right. General specifications are rounded. Metric conversions are calculated before rounding the Imperial measurement.

Ferno reserves the right to change specifications without notice. For more information, contact Ferno Customer Relations or your Ferno distributor (page 2).

- **Height/Rolling Position** measurements are the distance from the ground to the patient surface, measured at the center of the seat panel.
- **Ambulance Floor/Tray Range** is the recommended height range for the ambulance floor for proper loading and unloading.
- **Weight** is without pad, patient restraints and optional features.
- All Ferno® pads for emergency medical service use are fully-sealed.



Load Capacity

Inspect the cot if the load capacity has been exceeded. See "Inspecting the Cot" on page 31.

All Models

Specifications	Imperial	Metric
Load Capacity	620 lb	280 kg
Load Capacity (UK)		44 st
Weight	98 lb	44.45 kg
Cot Construction	Aluminum	
Patient Surface	Aluminum Panels	
Wheel Bearings	Sealed/greaseless	
Wheels (Diameter x Width)	6 in. x 2 in	150 x 44 mm

Model MB64

Dimensions	Imperial	Metric
Height		
Rolling Position 6	37 in	949 mm
Bed Position 5	35 in	895 mm
Bed Position 4	32.5 in	825 mm
Bed Position 3	28 in	715 mm
Bed Position 2	22.5 in	570 mm
Bed Position 1	13 in	330 mm
Folded (Ambulance) Height	12 in	310 mm
Width	22 in	553 mm
Length	77.5 in	1970 mm
Ambulance Floor/Tray Range	27-29 in	670-730 mm

Model MB70

Dimensions	Imperial	Metric
Height		
Rolling Position 6	40 in	1006 mm
Bed Position 5	37 in	946 mm
Bed Position 4	34 in	871 mm
Bed Position 3	30 in	752 mm
Bed Position 2	23 in	593 mm
Bed Position 1	12 in	314 mm
Folded (Ambulance) Height	13 in	327 mm
Width	22 in	553 mm
Length	77.5 in	1970 mm
Ambulance Floor/Tray Range	29-31 in	730-790 mm

3.4 Cot Positions

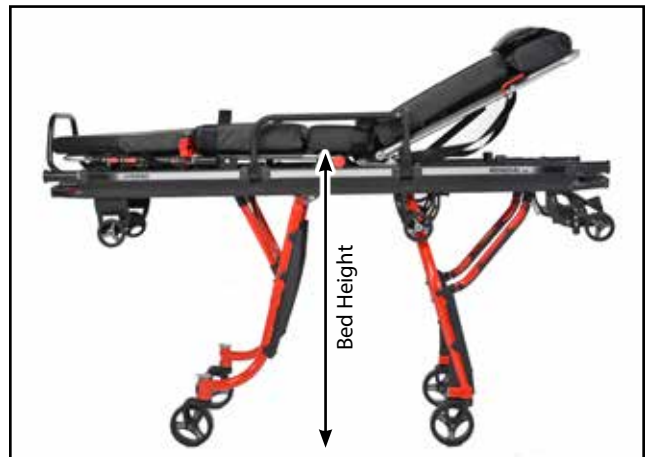

4 - SETUP

4.1 Ambulance Information

The patient compartment should have a level floor large enough for the folded cot, and a Ferno® fastening system installed (not included). See “Fastening System Compatibility” on page 4.

4.2 Restraints, Pad and Accessories

Before placing the cot in service, assign appropriate personnel to install the pad, patient restraints, and any accessories shipped with the cot. Keep restraint and accessory users’ manuals with this manual for future reference. For additional, free manuals, contact Ferno Customer Service (page 2).

HARNESS COMPONENTS

- Each of the four straps of the harness are constructed with a bracket button to secure the strap to the cot (Figure 1).
- The shoulder straps and receiver-end of the waist strap have adjustment sliders that allow the length of the strap to be adjusted.
- The waist strap tang is designed to pass through the two shoulder-strap links and then fasten to the receiver.
- The one-piece lap/leg strap ends have sewn loops allowing the strap to be wrapped and secured to the cot.

RESTRAINT GUIDELINES

A set of patient restraints is supplied to properly secure a patient (Figure 1). The set includes a four-point harness restraint to secure the patient’s torso and a two-piece restraint to secure the patient’s legs.

To comply with CEN crash standards, a **complete set** of patient restraints must be attached and used as shown in this manual.

- Unbuckle the restraints and lay the straps out of the way before transferring the patient.
- Adjust restraints to safely secure the patient without causing discomfort or impairing circulation.
- Place restraints to cross bony parts of the body, following local protocols for restraint placement.
- Ferno recommends that the two-piece restraint be attached at the knees.
- Additional restraints may be required by the local government authority. Follow local protocols and regulations.
- Keep restraints fastened when not in use to prevent them from interfering with cot operation.
- Dispose of and replace restraints that are worn, damaged, or have been involved in a vehicular accident. Restraints that have been involved in a vehicular accident may have damage that is not visible to the eye.

⚠ WARNING

Attaching improper items to the cot can cause injury. Use only Ferno-approved items on the cot.

Important

Loose items and debris on the patient compartment floor can interfere with the operation of the cot with the fastening system. Keep the patient compartment floor clear.

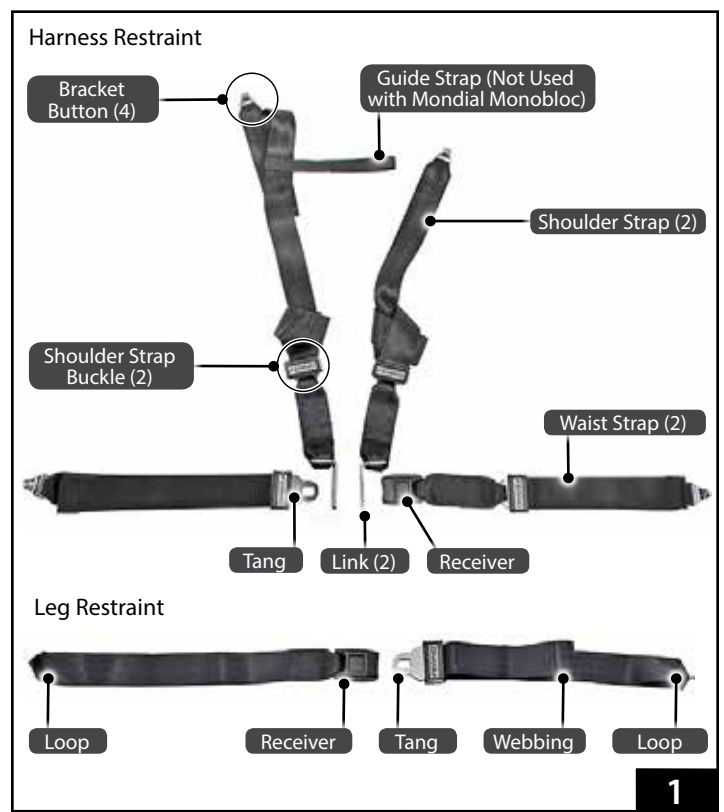

4.3 Attaching the Leg Restraint

Restraint brackets are provided for attaching the two-piece leg restraint.

1. Unbuckle the restraint, separating it into its two straps.
2. Raise the shock frame.
3. Thread the loop end of the strap through the bracket attached under the shock frame, then pass the receiver or tang-end of the restraint through the loop (Figure 2).
4. Pull the strap to tighten the knot against the bracket.
5. Adjust the length of the restraint so it can be easily buckled.



4.4 Attaching the Harness

BRACKET BUTTON SYSTEM

A metal button is affixed to the end of each harness shoulder strap and waist strap. The buttons seat into metal keyhole brackets mounted on the cot main frame to secure the restraint on the cot.

The brackets are located on the inside (patient side) of the main frame, where the backrest and bed seat sections meet (Figure 3). Each bracket has two keyholes: one for the shoulder strap and one for the waist strap.

The restraint keeper is a spring-loaded piece of metal that assists with holding the restraints in place (Figure 3).

ATTACHING THE WAIST STRAPS

1. Lower the sidearms and raise the backrest.
2. Separate the restraint into its component pieces.
3. Pull the restraint keeper outward slightly to access the keyhole bracket (Figure 3). Hold it in this position while completing Step 4.
4. Working from the inside (closest to the patient surface), insert the waist-strap button into the bracket keyhole closest to the control end of the cot. Pull the button firmly upward to seat it in the narrow portion of the keyhole (Figure 4).
5. Release the restraint keeper.



Tip

Attaching Waist Straps

Attach the waist straps to the keyhole bracket nearest the control end of the cot.

Pressing the rear of the strap/button against the bracket as you pull upward will help seat the button in the bracket.

The restraint keeper helps prevent accidental removal of the restraints from the bracket.

ATTACHING THE SHOULDER STRAPS

Attaching the shoulder straps will be easier if you first buckle the waist and shoulder straps by placing the shoulder strap links onto the tang and then insert the tang into the receiver.

1. Lay the shoulder straps flat on the backrest. Verify that the straps are not twisted.
2. Pass both shoulder straps through the slots in the pad and bed frame. The guide strap is not used.
3. Pull the loading-end of the restraint keeper outward slightly to access the keyhole bracket, similar to Figure 3 on page 12. Hold it in this position while completing Step 4.
4. Working from the inside (closest to the patient surface), insert the shoulder-strap button into the bracket keyhole closest to the loading end of the cot. Pull the button firmly upward to seat it in the narrow portion of the keyhole (Figure 5).
5. Release the restraint keeper.
6. The attached shoulder straps should look similar to those shown in Figure 6.



Tip

Attaching Shoulder Straps

Attach the shoulder straps to the keyhole bracket nearest the loading end of the cot.

Pressing the rear of the strap/button against the bracket as you pull upward will help seat the button in the bracket.

5 - USING THE FEATURES

5.1 EZ Pull™ Leg Control Handles

- **Purpose:** Unlocks the legs nearest the handle, allowing the cot to be lowered.
- **Use:** The EZ Pull handle (Figure 7) allows the operators to operate the handle before lifting the cot so they can grasp the cot with both hands and lift evenly. For complete instructions, see “Using the Cot” on page 23.
 - **Lowering the cot:** Operators pull both control handles at the same time, then lift the cot to take the weight off the locking mechanism. The leg-status indicator will change to red and the cot can be lowered. See “Leg-Status Indicator” on page 14.
 - **Raising the cot:** The leg control handles are not used. The operators simultaneously lift the cot main frame until the cot locks at the desired height.
 - **During loading:** The Control-end Operator uses the control-end handle when loading the cot into an ambulance.

Note: If the cot is equipped with the Smart-Load™ automatic leg-release option, the control handle is not used when loading the cot into an ambulance. See “Smart-Load Automatic Leg Release” on page 21.



5.2 Leg-Status Indicator

- **Purpose:** Indicates the status of the leg lock.
- **Use:** The indicator, located inside each control panel (Figure 8) changes automatically when the leg control handle at the same end of the cot is used.
 - **Green:** The legs are locked.
 - **Red:** The legs are unlocked (the leg-control handle has been pulled) and the cot may be lowered or loaded into an ambulance.
 - Always maintain your grasp on the cot until you verify that both legs have locked at the new position.

Important

The leg-status indicator displays the state of the undercarriage leg lock:

GREEN = Locked/Safe

RED = Unlocked/Ready to Lower or Load



5.3 Swivel-Lock Release Lever

- **Purpose:** The lever unlocks and allows the loading-end caster wheels to swivel 360°.
 - By default, the casters are locked. The caster wheels can roll but cannot swivel. The casters must be locked before loading the cot into an ambulance.
 - When unlocked, the caster wheels can roll and swivel 360°, allowing the cot to be maneuvered easily when space is limited.
- **Use:**
 - To unlock the casters for swiveling, the Loading-end Operator pulls and holds the blue swivel-lock release lever (Figure 9). The operator must continue holding the lever as long as the swivel function is needed.
 - To lock the casters, let go of the lever and roll the cot toward the loading end until the wheels rotate and lock. This allows the pin inside the trailing end of the caster to engage the lock (Figure 10).

GUIDELINES FOR USE

- The cot is more stable when the casters are locked and is more maneuverable when the casters can swivel.
- The swivel-lock release lever functions only when the cot is in the highest rolling position (Bed Position 6).
- Lock the casters **before** loading the cot into an ambulance so the wheels will not swivel and interfere with loading or unloading.
- Lock the casters **before** lowering the cot. At a lower position, shifting weight on the cot can cause an unlocked loading-end caster to swivel suddenly.
- To maintain proper function of the swivel caster lock pins, clean as needed with water and a mild detergent. If this is insufficient, lubricate the lock pins. See “Lubricating the Cot” on page 32.

WARNING

Releasing the swivel locks increases the possibility for the cot to tip. Maintain control of the cot at all times.

Important

The loading-end caster wheels lock only when the swivel lock release lever is released **and** the trailing end of each caster orients with the lock pin.



5.4 Wheel Locks

- **Purpose:** Aid in keeping the cot from rolling during patient transfer and certain medical procedures
- **Use:** To engage the wheel lock, press the lock lever on top of the caster (Figure 11). To disengage the lock, lift the lever up with your toe.

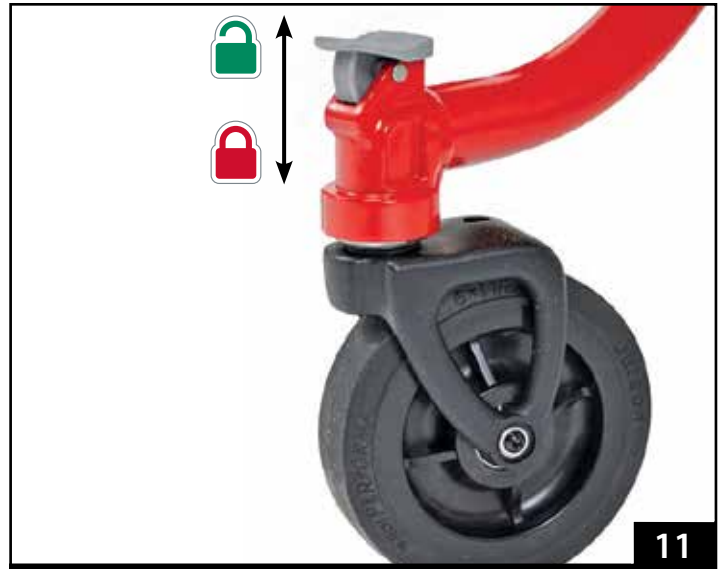

5.5 Sidearms

- **Purpose:** Sidearms provide patient security and comfort. Keep the sidearms raised except during patient transfer.
- **Use:**
 - To lower, press the release button and swing the sidearm **slightly toward the patient** to release the lock (Figure 12), then swing the sidearm down and away from the patient.
 - To raise, rotate the sidearm upward until it locks.
 - Sidearms also lock at 90 degrees.

Important

Do not use the sidearms to lift the cot. Sidearms are not designed for lifting. Lift the cot only by grasping the main frame.



5.6 Footrest

- **Use:** The permanent, built-in footrest (Figure 13) provides stability and support for a patient's feet. The footrest can also be used by the Control-end Operator to pull and steer the cot while rolling it.



5.7 Shock Frame

In addition to the flat position, the shock frame adjusts to two raised positions:

- Raised shock position (Modified Trendelenburg position, Figure 14) elevates the patient's feet.
- Contour shock position (Fowler's position, Figure 16) to elevate the patient's knees higher than the feet.

Follow your local medical protocols when deciding which position to use. Use an underhand grip (palms up) to support the shock frame while raising or lowering it. Always work from the control end of the cot. Raising and lowering from the side can expose your hand to pinch points.

RAISED (MODIFIED TRENDLENBURG) SHOCK POSITION

Raising:

1. Unfasten or loosen the leg restraint.
2. Working from the control end of the cot, lift the shock frame with both hands until it locks in the raised position (Figure 14). The support bars engage automatically.
3. Fasten and adjust the leg restraint.

Lowering:

1. Unfasten or loosen the leg restraint.
2. Working from the control end of the cot, support the weight of the shock frame with both hands and lift slightly.
3. With your thumbs, press the shock frame control levers to disengage the support bars (Figure 15), then lower the shock frame.
4. Fasten and adjust the leg restraint(s).

CONTOUR (FOWLER'S) SHOCK POSITION

Raising:

1. Unfasten or loosen the leg restraint(s).
2. Working from the control-end of the cot, grasp the lifting strap with one hand and the foot end of the shock frame with your other hand.
3. Lift the shock frame with the lifting strap while sliding the foot end of the shock frame toward the head end of the cot (Figure 16) until it locks in the contour position.
4. Fasten and adjust the restraints.

Lowering:

1. Unfasten or loosen the leg restraint(s).
2. Working from the control-end of the cot, use the lifting strap to lift the shock frame slightly.
3. With your thumb, press the shock frame control lever (Figure 17) to disengage the support bars, then lower the shock frame.
4. Fasten and adjust the restraint(s).



14



15

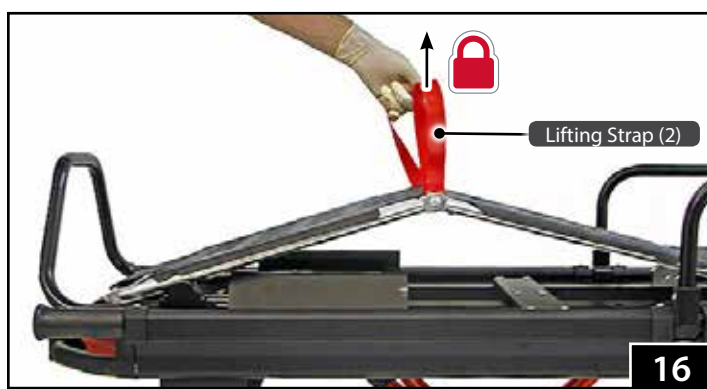

16

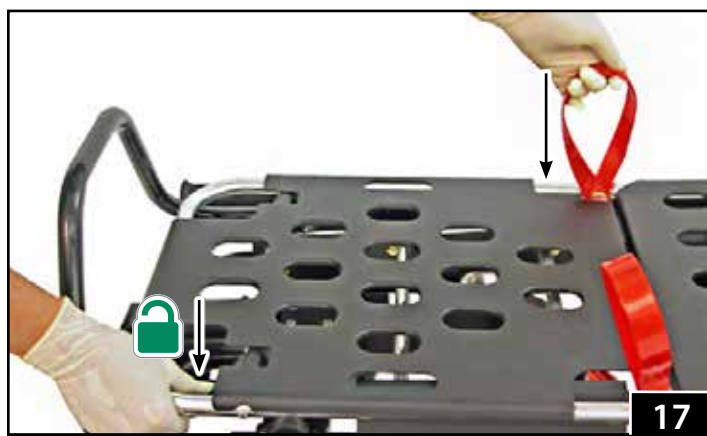

17

5.8 Backrest

- **Purpose:** The backrest allows the operator to elevate the patient's torso for patient comfort or medical necessity.
- **Before Use:** Loosen or unbuckle the torso restraint. Support the weight of the backrest and patient.
- **Use:** A red, backrest control handle is located on either side of the backrest frame (Figure 18). Press the control handle **down, toward the main frame** to unlock the backrest, then raise or lower the backrest to the desired position. Release the control handle to lock the backrest at the new position.
- The gas spring is under pressure to ease raising and lowering. When a heavy patient is on the cot, support the patient's weight before adjusting the backrest. When a light patient is on the cot, control the upward movement of the backrest so it does not move too quickly.
- **After Use:** Buckle and adjust the torso restraint.

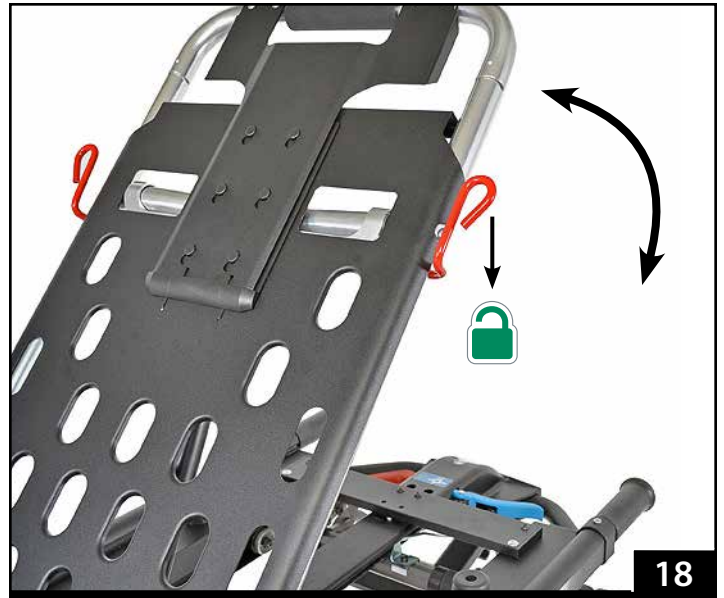

5.9 Backrest with Extending Headrest (Optional)

- **Purpose:** Extend the headrest to make the patient surface longer for a tall patient. This feature extends the patient surface approximately 7 in. (180 mm).
- **Use:** To extend the headrest, pull the frame until it stops at the extended position (Figure 19). To retract, push the frame in until it stops.

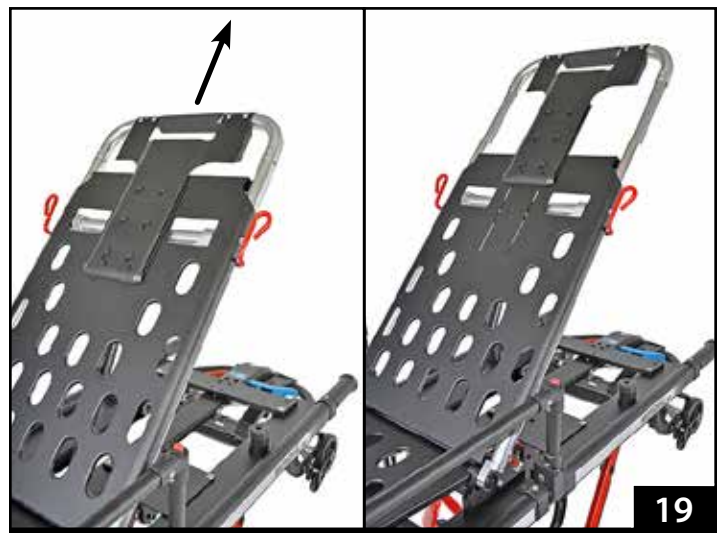

5.10 Backrest with Airway Management Frame (Optional)

- **Purpose:** The airway management frame allows the head section of the backrest to be adjusted between three locking positions to allow trained medical personnel to access and work with the patient's airway.
- **Use:** To adjust the frame, pull the release bar (Figure 20), and rotate the frame to the new position. Let go of the bar to allow the frame to lock.



5.11 Intermediate Loading Wheels

- **Purpose:** Reduces the amount of lifting required when loading the cot into an ambulance and when unloading the cot from an ambulance.
- **Use:** The intermediate loading wheels (Figure 21) are passive aids and do not require any action on the part of the operators.



5.12 Leg Lock (Optional)

- **Purpose:** The leg lock secures both cot legs in Bed Position 1 or Bed Position 3. This allows the cot to be lifted without the legs extending. Use additional help as needed to carry the cot. See "Using Additional Help" on page 7.
- **To engage the leg lock:**
 1. **Both Operators:** Raise or lower the cot to Bed Position 1 or Bed Position 3. See "Cot Positions" on page 10.
 2. **Control-end Operator:** To engage the leg lock, pull the blue leg lock lever toward the control end of the cot (Figure 22).
 3. **Both Operators (and Helpers, if needed):** Lift and carry the cot. See "Carrying the Cot" on page 29. Set the cot down when you reach the destination.
- **To disengage the leg lock,** the control-end operator pushes the blue leg lock lever toward the loading end of the cot (Figure 22).

Important

If the legs do not unfold as the cot is removed from the ambulance, check the leg lock. Push the cot back inside the ambulance, release the lock, and start the unloading process again. Do not force the legs down.

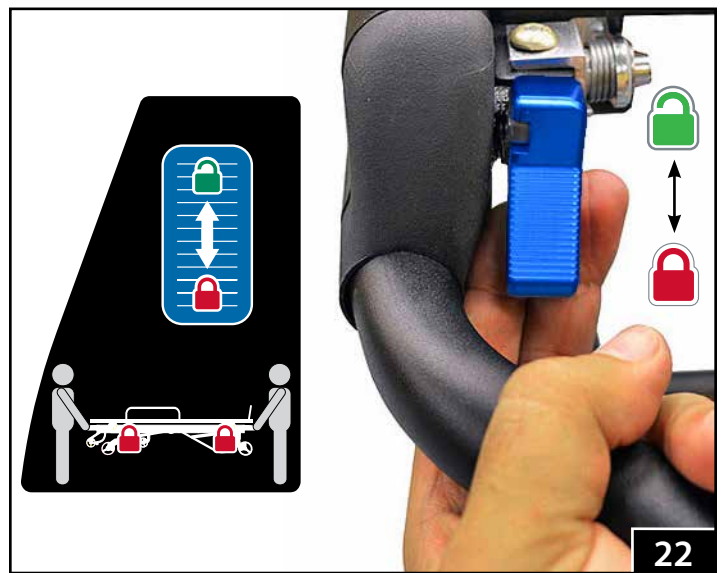

5.13 Telescoping Handles (Optional)

- **Purpose:** The optional telescoping handles extend to aide the operator to lift and carry the cot. The handles lock in three positions (Figure 23):
 - Fully retracted
 - Middle (about 5 in/125 mm)
 - Fully extended (about 9 in/225 mm)
- **Use:** Press the button on the end of the handle (Figure 24) and push or pull the handle to the desired position. Release the button and pull or push the handle until it locks. Use the telescoping handles only when they are in a locked position.

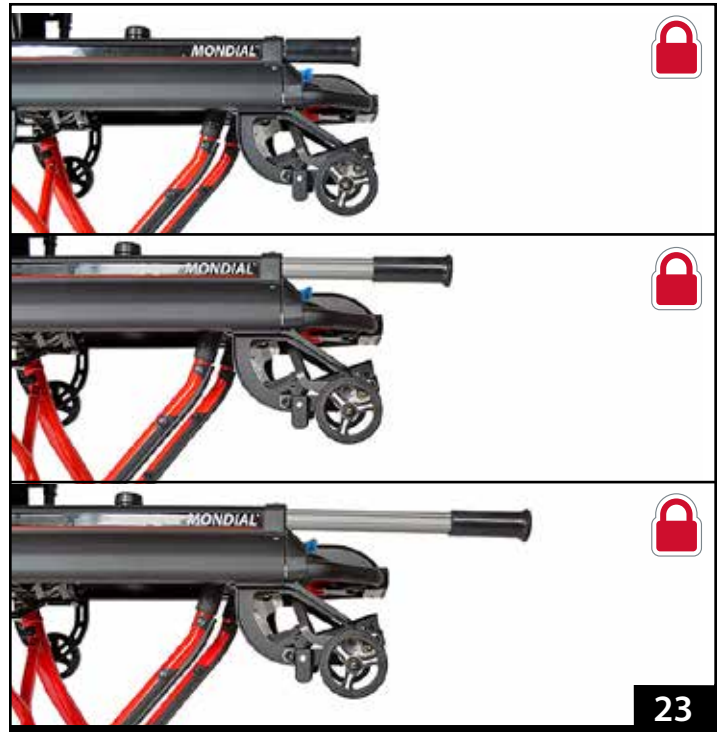

5.14 Telescoping Side Handles (Optional)

- **Purpose:** Operators or helpers use the side handles as extra lifting or grasping points.
- **Use:** Pull to extend the handle. Push to retract (Figure 25).
 - Grasp the cot main frame with one hand, using an underhand grasp. Grasp the side handle with your other hand, using a cylindrical grip.
 - When lifting, balance the cot by placing one operator or helper on each side of the cot and lift together, using both handles.



5.15 Smart-Load™ Automatic Leg Release (Loading-End Legs)

- **Purpose:** A mechanism connected to the loading wheels (Figure 26) automatically unlocks the loading-end legs for folding as the cot is loaded into an ambulance.
- **Use:** The automatic leg release is a passive device that does not require any action on the part of the operators.

Important

Do not hang a defibrillator or other object on the loading-end main frame. Objects hanging from the main frame could activate the leg-release mechanism.

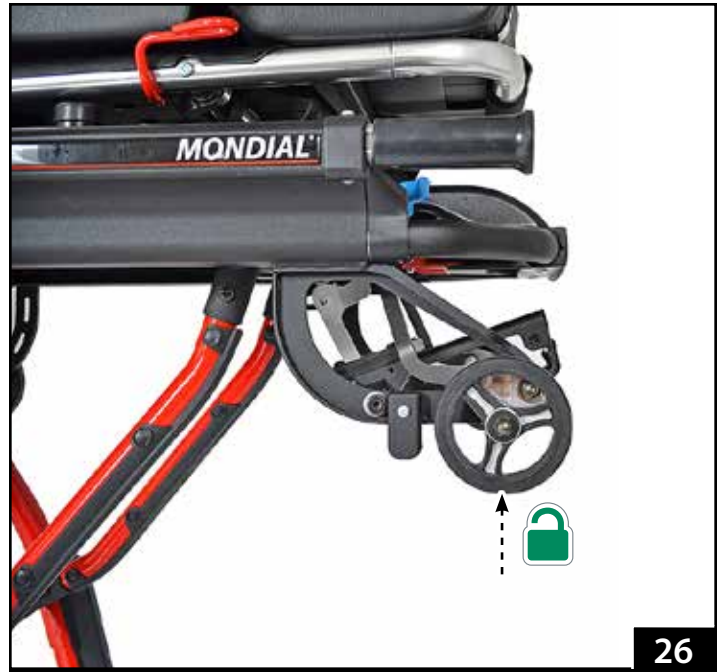

5.16 Smart-Load™ Automatic Leg Release (Control-End Legs, Optional)

- **Purpose:** When the cot is equipped with this optional feature, the operators do not use any control handles when loading the cot into an ambulance.
- **Use:** As the cot is loaded into the ambulance and after the loading-end legs fold, the control-end legs are automatically unlocked for folding. See "Loading the Cot" on page 27.

Smart-Load™ Overview

When a cot equipped with both loading-end **and** control-end Smart-Load™ leg release mechanisms is loaded into an ambulance, the following sequence occurs:

1. The operators begin loading the cot into the ambulance.
2. The weight of the cot on the loading wheels unlocks the loading-end legs for folding.
3. The operators continue pushing the cot into the ambulance **while balancing and supporting the remaining load** when the loading-end legs are unlocked.
4. The loading-end legs fold and automatically unlock the control-end legs for folding.
5. The operators finish pushing the cot into the ambulance and secure it in a Ferno® fastening system.

5.17 Safety-Lock Device (Optional)

- **Purpose:** The Safety-Lock Device prevents the cot from being accidentally unloaded from the ambulance before the loading-end legs have locked.
 - The optional Safety-Lock Device is required in some countries. Check the requirements for your country.
 - The Safety-Lock Device consists of a hook installed under the loading end of the cot (Figure 27) and a user-installed catch plate installed on the ambulance floor or ramp. Contact Ferno to order the appropriate SLD kit. See “Ferno Customer Relations” on page 2 and “Accessories” on page 34.
- **Use:** As the operators unload the cot from the ambulance:
 - **If the loading-end legs have not locked:** The SLD hook installed on the cot will catch on the user-installed catch plate. If this happens, raise the control end of the cot until the loading-end legs swing down completely and lock. Use additional help as needed to lift the cot. See Using Additional Help, page 29.
 - If the loading-end legs have locked: No action is needed. The hook on the cot will not catch on the catch plate and the cot may be unloaded normally.



5.18 Storage Tray (Optional)

- **Purpose:** The optional storage tray is integrated with the cot under the backrest (Figure 28).
- **Use:** Raise the backrest to place objects on the storage tray. Remove objects before lowering the backrest. Do not allow objects on the tray to interfere with the backrest pneumatic spring.



6 - USING THE COT

6.1 Before Placing the Cot in Service

- Before use, personnel who will work with the cot must read and understand this manual. Appropriate skills and training are also required. See “Operator Training” on page 6.
- Set up the cot, following the instructions “Setup” on page 11.
- Confirm that the cot operates properly. See “Inspecting the Cot” on page 31.
- The vehicle must have a Ferno® fastening system installed. See “Compatible Fastening Systems” on page 8.

6.2 General Guidelines for Use

- Medical advice is beyond the parameters of this manual.
- It is the users’ responsibility to ensure safe practices for the patient and themselves.
- A **minimum** of two trained operators is required.
- Follow standard emergency patient-handling procedures when operating the cot.
- **Operators work together and maintain control of the cot at all times.**
- Operators **must** communicate with one another and use coordinated movements to operate the cot.
- Operators **must** stay with the patient at all times.
- **Always** use patient restraints to secure the patient on the cot.
- Select appropriate restraints for the patient being transported. A list of Ferno patient restraint systems compatible with the cot is at right.
- Lift only the weight you can safely handle. Use additional help when working with heavy loads (patient and equipment). For placement of helpers, see “Using Additional Help” on page 7.
- When changing cot positions or when unloading it from an ambulance, verify that both sets of legs have locked into the new Bed Position before you release your grasp on the main frame.
- Read the fastening system users’ manual for instructions on using the fastening system. See “Fastening System Compatibility” on page 4.

 **WARNING**

Improper operation can cause injury. Operate the cot only as described in this manual.

An unattended patient can be injured. Stay with the patient at all times.

An unrestrained patient can be injured. Use patient restraints to secure the patient on the cot.

Rolling the cot sideways can cause it to tip and injure the patient or operators. Roll the cot only with the loading end or control end first.



Load Capacity

Inspect the cot if the load capacity has been exceeded. See “Inspecting the Cot” on page 31.



Read the Users’ Manual



Operation Requires Two Trained Operators

Ferno Patient Restraint Systems (Not Supplied)

Ferno Product	Metric Patient Weight	Imperial Patient Weight
Model 678 Pedi-Mate®	4.5-18.1 kg	10-40 lb
Mondial® Harness and Leg Restraint	Up to Rated Load Capacity	

*Follow local protocols for selection and application of patient restraints. See “Accessories” on page 34.

6.3 Changing Cot Positions

Changing cot positions with a patient on the cot requires a **minimum** of two trained operators who are communicating, working together, and maintaining control of the cot at all times.

PREPARING TO RAISE OR LOWER THE COT

1. **Both Operators:** Engage the loading-end caster swivel locks so the wheels will not swivel. See “Swivel-Lock Release Lever” on page 15.
2. **Both Operators:** Stand at opposite ends of the cot (Figure 29).
3. **Both Operators:** Use an underhand grip to grasp the cot main frame and position your right hand to use the leg-control handle (if needed).

RAISING THE COT

Operators do not use any control handles when raising the cot.

1. **Both Operators:** Lift the cot until it is near the desired height. If the legs remain locked in Bed Position 1 or Bed Position 3 when you attempt to raise the cot, the leg lock may be engaged. Stop the raising process; verify the cot is locked at the current height, and allow the Control-end Operator to disengage the leg lock. See “Leg Lock” on page 19.
2. **Both Operators:** Verify that the cot has locked at the new height before relaxing your grasp.

LOWERING THE COT

1. **Both Operators:** Squeeze and hold the leg control handle with your right hand.
2. **Both Operators:** Lift the cot slightly to take the weight off the locking mechanism and allow the locking mechanism to disengage. The leg-status indicator will change to red.
3. **Both Operators:** Together, lower the cot (Figure 29).
4. **Both Operators:** Release the leg control handles when the cot is near the desired height. Continue lowering until the locking mechanism engages.
5. **Both Operators:** Do not release your grasp until you are sure the undercarriage is locked at the new position.
6. **Both Operators:** If the legs have not locked, raise the cot a little higher until you hear an audible “click” from the locking mechanism, then retest.

Tip

Talk to the Patient

Communicate before making changes to the cot height, and during the loading and unloading procedures.



6.4 Transferring the Patient Onto the Cot

1. Unfasten the patient restraints. Arrange the straps so they will not interfere with transferring the patient onto the cot.
2. Lower the sidearms and retract the side lift handles.
3. Roll the cot as near as possible to the patient. Adjust the cot height to the patient's level.
4. Engage the wheel locks.
5. Transfer the patient onto the cot using approved emergency medical procedures and following your local protocols.
6. Raise the sidearms. Adjust the backrest and shock frame as needed.
7. Fasten and adjust the patient restraints (Figure 30).
8. Release the wheel locks.
9. Before moving the cot or changing its Bed Position, make sure sheets and other articles will not interfere with cot operation.
10. Raise the cot to a suitable rolling height. See "Rolling the Cot" on page 26.

Important

Sheets or other articles that are placed, or find their way, beneath the patient surface can become caught in the locking mechanism and cause it to malfunction. Tuck sheets between the pad and the patient surface. Keep other articles above the pad.



6.5 Rolling the Cot

GENERAL GUIDELINES

- Rolling the cot with a patient on the cot requires a **minimum** of two trained operators who are communicating, working together, and maintaining control of the cot at all times.
- Use Bed Position 6 to roll the cot. Note that the cot must be in Bed Position 6 to unlock the loading-end caster swivel locks.
- Roll the cot on smooth, unobstructed surfaces whenever possible.
- To cross a low obstacle such as a door sill, lift the cot slightly to take the weight off the wheels so the wheels roll smoothly over the obstacle.
- Lift and carry the cot over a high obstacle such as a curb. **Do not** apply downward force on one end of the cot in order to raise the other end of the cot.
- If the cot is equipped with the auxiliary leg lock, the operators may fold the cot and carry it.
- Do not roll the cot sideways. Rolling a cot sideways can increase the chance for the cot to tip and injure the patient and/or operators.
- Use additional help as needed to safely control the weight of the patient and cot. See "Using Additional Help" on page 7.
- When rolling over rough terrain, the operators (and helpers) should grasp the cot main frame with both hands.

ROLLING THE COT

1. Securely fasten the restraints around the patient.
2. **Both Operators:** Place the cot at a suitable rolling height and unlock the wheel locks. See "Cot Positions" on page 10.
 - If the swivel function on the loading-end wheels is needed, place the cot in Bed Position 6. See "Swivel-Lock Release Lever" on page 15.
 - If you are rolling the cot in the control-end direction (feet first), the loading-end operator should unlock the loading-end caster wheels.
3. **Control-end Operator:** Position yourself at the side of the cot near the patient's feet (Figure 31) or at the control end of the cot. Grasp the main frame and/or footrest to roll the cot.
4. **Loading-end Operator:** Position yourself at the loading-end of the cot (Figure 31) or at the side of the cot near the patient's torso. Grasp the main frame. Attend the patient and assist in rolling and steering the cot.

WARNING

Rolling the cot sideways can cause the cot to tip and injure the patient or operators. Roll the cot only with the loading-end or control-end first.

Important

Roll the cot downhill control-end first.

If it is not medically appropriate to do this, roll the cot loading-end first **and** have the Assisting Operator exert upward force on the main frame to help maintain cot balance.



6.6 Loading the Cot

Loading the cot into an ambulance with a patient on it requires a **minimum** of two trained operators who are communicating, working together, and maintaining control of the cot at all times.

Note: Use additional help as needed when working with heavy loads (patient and equipment). See "Using Additional Help" on page 7.

1. If the ambulance has a folding tray, lower the ramp.
2. **Both Operators:** Raise the cot to Bed Position 6 (the highest position) and verify that the loading-end swivel casters are locked so they will not swivel during loading.
3. **Loading-end Operator:** Stand at the side of the cot, grasp the main frame, and assist the Control-end Operator in loading the cot into the ambulance.
4. **Control-end Operator:** Grasp the cot main frame using an underhand (palms up) grip and begin pushing the cot into the ambulance. Roll the cot forward until both loading wheels are on the patient compartment floor (or tray) and the loading-end legs contact the bumper. The loading-end legs will automatically begin to fold (Figure 32 and 33).

Note: If the cot is equipped with the Smart-Load™ automatic control-end leg release, the Control-end Operator may choose to grasp the cot frame or telescoping handles to push the cot into the ambulance.

5. **Both Operators:** Before the rear legs contact the ambulance bumper, support and balance the remaining weight of the cot, patient and equipment.
6. **Control-end Operator:**
 - o **Cot WITHOUT Smart-Load™ control-end leg release:** Squeeze the control-end leg control handle to unlock the control-end legs. Continue pushing the cot into the ambulance.
 - o **Cot WITH Smart-Load™ control-end leg release:** The control-end legs will automatically unlock and begin to fold after the loading-end legs have folded. Continue pushing the cot into the ambulance.
7. **Either Operator:** Secure the cot in a Ferno fastening system. Fold the folding tray ramp if needed.

Tip

Talk to the Patient

Communicate before making changes to the cot height, and during the loading and unloading procedures.



Important

If the legs do not unfold as the cot is removed from the ambulance, check the leg lock. Push the cot back inside the ambulance, release the leg lock, and start the unloading process again.

If the ambulance is in a low area or on an incline, the operators (and any helpers) may need to lift the cot to allow each set of legs to lock.

6.7 Unloading the Cot

Unloading the cot from an ambulance with a patient on it requires a **minimum** of two trained operators who are communicating, working together, and maintaining control of the cot at all times.

Note: Use additional help as needed when working with heavy loads (patient and equipment). See "Using Additional Help" on page 7.

1. **Both Operators:** If the ambulance has a folding tray, lower the ramp. Then, release the cot from the fastening system.
2. **Control-end Operator:** Grasp the main frame with an underhand (palms up) grip. Roll the cot out of the ambulance until the control-end legs unfold and lock. If the legs do not unfold, the leg lock is engaged. Push the cot back inside the ambulance, unlock the leg lock, and re-start the procedure.
3. **Loading-end Operator:** As the cot is rolled out of the ambulance, grasp the main frame and assist the Control-end Operator (Figures 34-35).
4. **Control-end Operator:** Verify that the control-end legs have locked. See "Leg-Status Indicator" on page 14.
5. **Both Operators:** Continue rolling the cot out of the ambulance until the loading-end legs unfold completely and lock. Keep the loading-wheels on the ambulance floor (Figure 35).
6. **Loading-end Operator:** Place your foot against one wheel of the loading-end legs and verify that the legs have finished swinging to their final, locked position.
7. **Both Operators:** Roll the cot out of the ambulance.

SAFETY-LOCK DEVICE REMINDER

During unloading, cots equipped with the (optional) Safety-Lock Device may catch on the catch plate. If this happens, raise the cot control-end high enough for both sets of legs to unfold and lock. Use additional help as needed. This will allow the cot to be removed from the catch plate.

Tip

Talk to the Patient

Communicate before making changes to the cot height, and during the loading and unloading procedures.

WARNING

An unlocked undercarriage can cause injury. Before removing the cot from the ambulance, confirm that both sets of legs unfold completely and lock.



6.8 Carrying the Cot

The legs may be locked in Bed Position 1 or Bed Position 3 to allow the operators to lift and carry the cot over rough terrain or obstacles. To engage the leg lock:

1. **Both Operators:** Raise or lower the cot to Bed Position 1 or Bed Position 3. See “Changing Cot Positions” on page 24.
2. **Control-end Operator:** Engage the leg lock by pulling the blue leg lock lever toward the control end of the cot (Figure 36).
3. **Both Operators (and any helpers):** Grasp the cot main frame and lift and carry the cot.

To disengage the leg lock:

1. **Both Operators:** Set the cot on the ground or flat surface.
2. **Control-end Operator:** Disengage the leg lock by pushing the blue lever toward the loading end of the cot (Figure 36).

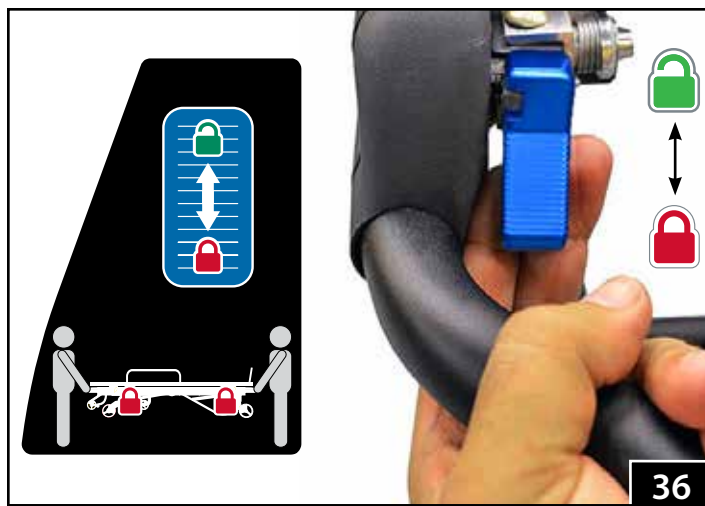

Tip

Check the Leg Lock

Do not engage the leg lock while the cot is inside an ambulance.

Do Not Load a Folded Cot

The cot cannot be loaded into an ambulance while in the folded position. Set the cot down, disengage the leg lock, and raise the cot fully. Then follow the standard loading process. See “Loading the Cot” on page 27.

6.9 One Operator, Empty Cot

LOADING AND UNLOADING

When the cot is empty (no patient), and if local protocols permit, an empty cot may be loaded into and unloaded from the ambulance by one trained operator (Figure 37). Follow the procedures in “Loading the Cot” on page 27 and “Unloading the Cot” on page 28.

CHANGING POSITIONS

When the cot is empty (no patient), and if local protocols permit, one operator can change the cot height. To raise the cot, raise one end of the cot, then the other.

To lower the cot, squeeze the leg-control handle at one end of the cot and lower the cot to the desired position (Figure 38), then move to the opposite end and repeat the process.

If equipment is on the cot, raise or lower the cot in stages by adjusting the height only one or two positions at a time. Prevent loose items from sliding off the cot.



7 - MAINTENANCE

7.1 Maintenance Schedule

The cot requires regular maintenance. Set up and follow a maintenance schedule. The table at right represents minimum intervals for maintenance. Also see the "Recommended Routine Parts Replacement Schedule" on this page.

Keep maintenance records. For a sample record sheet, see "Maintenance Record" on page 35.

When using maintenance products, follow the manufacturers' directions and read the product material safety data sheets.

7.2 Tracker™ (Optional)

The optional Tracker™ device attaches to the undercarriage and counts cot cycles. A cycle is recorded each time the cot moves from the folded position to a raised position and back. The total number of cycles is displayed on an LCD readout.

Use the Tracker™ as an aid to schedule and record cot maintenance.

Note: *The Tracker™ is designed to maintain a count of the total number of cot cycles. It is not designed to be reset to zero.*

7.3 Disinfecting and Cleaning the Restraints

To disinfect:

1. Remove restraints from the cot.
2. Spray or wipe the metal buckles with disinfectant. Allow the disinfectant to remain on the buckles for the proper contact time. Wipe with a clean cloth. Do **not** immerse buckles in liquid.
3. Webbing may be immersed in disinfectant. Follow the disinfectant manufacturer's instructions for dilution and contact time.

To clean:

1. Remove restraints from the cot.
2. Add a mild soap or cleaning solution to warm water, using the recommended dilution.
3. Immerse the restraint webbing in the solution for the proper contact time. Do not immerse the buckles.
4. Repeatedly dip the restraint webbing in clear water to rinse. Do not immerse the buckles.
5. Hang the restraints to dry.
6. Attach clean, dry restraints to the cot. For installation directions, see "Setup" on page 11.

WARNING

Improper maintenance can cause injury. Maintain the cot only as described in this manual.

Minimum Maintenance	Each Use	As Needed	Monthly
Disinfecting (pages 30-31)	•		
Cleaning (pages 30-31)		•	
Waxing (page 31)		•	
Inspecting (page 31)		•	•
Lubricating (page 32)		•	

Important

Disinfectants and cleaners containing bleach, phenolics, or iodines can cause damage. Do not use products containing these chemicals.

Recommended Routine Parts Replacement Schedule

Inspect and replace the transporter parts listed below at the proper time or cycle count, whichever comes first. To order kits, see "Parts and Service" on page 33.

AS NEEDED

- 100 mm Loading wheel [190-2034]
- 150 mm Transport wheel [190-2044]
- Scuff strips [190-2035; 190-2046; 190-2045; 190-2047]

EVERY 3 YEARS OR 15,000 CYCLES

- Loading-end wheel caster (2) [190-2038]
- Loading-end swivel-lock pin and spring (2 ea.) [190-2054]
- Control-end wheel caster w/lock (2) [090-5922]
- Control-end wheel-lock lever, spring, and paddle (2) [190-2036]

EVERY 4 YEARS OR 20,000 CYCLES

- Leg control box assembly (each end) [090-5919]
- Loading-leg lock spring (2) [190-2043]
- Center control box assembly [090-5920] *

* **If equipped with control-end leg auto-release.**

7.4 Disinfecting and Cleaning the Pad

1. Remove the pad from the cot.
2. **To disinfect:** Apply disinfectant to the pad, following the disinfectant manufacturer's instructions for application method and contact time.
3. **To clean:** Wash the pad with warm, soapy water and a soft cloth. Rinse the pad with clear water. Hang the pad to dry, or dry it with a towel.

7.5 Disinfecting the Cot

Wipe all surfaces with disinfectant. Follow the disinfectant manufacturer's instructions for application method and contact time. Ferno recommends you inspect the cot for damage as you disinfect it.

7.6 Cleaning the Cot

1. Remove the patient restraints, pad and any accessories.
2. Hand clean all surfaces of the cot with warm water and a mild detergent.
3. Rinse with warm, clear water. Dry the cot with a towel or allow it to air-dry.

7.7 Waxing the Cot

While it is not necessary to wax this cot, waxing the painted legs will not damage them, and will help maintain the cot's appearance.

Disinfect and clean the cot before applying wax. Use an automotive wax as directed by the wax manufacturer.

Waxing the textured main frame is not recommended.

7.8 Inspecting the Cot

Have your service's equipment maintenance personnel inspect the cot regularly. Follow the checklist at right and operate the cot through all its functions as described in this manual.

If inspection shows damage or excessive wear, remove the cot from service until repair is made. See "Parts and Service" on page 33.

Important

Disinfectants and cleaners containing bleach, phenolics, or iodines can cause damage. Do not use products containing these chemicals.

Water under high pressure, or steam, can penetrate joints, flush away lubricant, and cause corrosion. Use caution when cleaning moving parts such as joints and hinges, and reapply lubricant if needed. See "Lubricating the Cot" on page 32.

Using abrasive cleaning compounds or applicators on the cot can cause damage. Do not use abrasive materials to clean the cot.

Inspection Checklist

- Are all components present?
- Is the cot free of excessive wear?
- Are all screws, nuts, bolts, rivets, (and roll pins for airway management frame) securely in place?
- Do all moving parts operate smoothly and properly?
- Does the cot lock properly into each position?
- Does the cot load and unload properly?
- Does the cot roll smoothly?
- Do the wheels have some tread?
- Do the wheel locks engage properly and stop wheel rotation?
- Do the swivel-locks function properly?
- Are the patient restraints properly installed?
- Is patient-restraint webbing in good condition with no cuts or frayed edges?
- Are patient-restraint buckles free of visible damage and do they operate properly?
- Is the ambulance properly prepared for the cot with an approved Ferno fastening system installed?
- Do installed accessories operate properly without interfering with cot operation?

7.9 Lubricating the Cot





Disinfect and clean the cot before applying lubricant. Use the lubricants designated below to lubricate the cot. Do not lubricate points marked with the "do not lubricate" symbol.

LUBRICATION POINTS

- | | | |
|----|------------------------------|--|
| 1. | Telescoping handle (4) | WRL-191S or E-Z-1 (1-2 drops) |
| 2. | Shock frame hinge (2) | WRL-191S or E-Z-1 (1-2 drops) |
| 3. | Loading-wheel linkage (4) | WRL-191S or E-Z-1 (1-2 drops) |
| 4. | Swivel-caster lock pins (2) | clean w/mild detergent/water (typical);
Clear synthetic grease/Loctite® 39342 ViperLube® (rarely) |
| 5. | Airway management hinge (2)* | WRL-191S or E-Z-1 (1-2 drops) |

*If equipped

LUBRICATION-FREE ITEMS

- | | | |
|---|--------------------------|------------------|
|  | Channel* | Do not lubricate |
|  | Rollers | Do not lubricate |
|  | Wheels (sealed bearings) | Do not lubricate |
|  | Leg pivot points | Do not lubricate |
|  | Backrest hinges | Do not lubricate |

* The channels do not require lubrication. Lubricating the channels or rollers will cause foreign particles to stick to the rollers and channel, causing damage.

Important

Lubricating parts that should not be lubricated allows dirt and foreign particles to collect on those parts, resulting in damage. Lubricate **only** the numbered reference points shown.

Tip

Applying Lubricant

Use a small amount of lubricant (one or two drops). Lubricate identical points on each side of the cot. After applying lubricant, wipe off any excess.



Do Not Lubricate



Lubricate

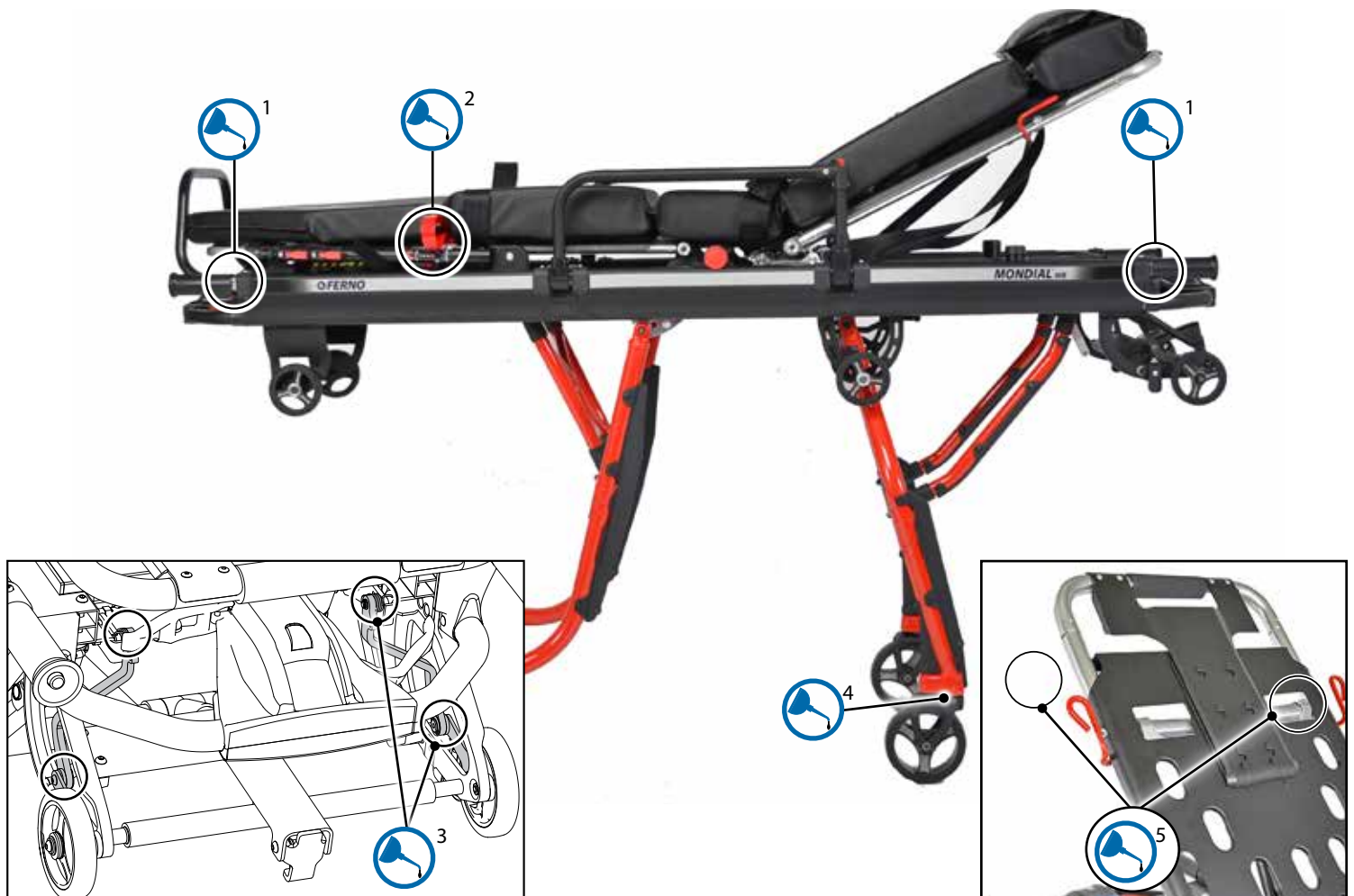

8 - PARTS AND SERVICE

8.1 U.S.A. and Canada

In the United States and Canada, to order parts or for professional repairs, contact EMSAR® – the only agent authorized by Ferno to manage, service, and repair Ferno products.

Telephone (Toll-Free)	1.800.73.EMSAR
Telephone	1.937.383.1052
Fax	+1.937.383.1051
Internet	www.EMSAR.com

8.2 Worldwide

To order Ferno parts, and for professional repairs, contact your Ferno distributor. Your distributor is the only agent authorized by Ferno to manage, service, and repair Ferno products.

WARNING

Improper parts and service can cause injury. Use only Ferno parts and Ferno-approved service on the cot.

Modifying the cot can cause injury and damage. Use the cot only as designed by Ferno.

Description	Parts Kit
Wheels, conductive (set of four, 150 mm/6" wheels)	083-2239
Wheel, 100 mm (4") w/hardware	190-2034
Wheel, 150 mm (6") w/hardware	190-2044
Wheel Fork (only), control end (w/internal lock plate, no pedal, and no wheel)	090-5922
Wheel Lock Mechanism, control end (w/pedal, spring, hardware, no fork or wheel)	190-2036
Wheel Fork Only (loading end, no wheel)	190-2038
Wheel Axle (loading end, w/hardware)	190-2040
Loading wheel w/hardware	190-2055
Loading-end leg bumper (pair, with hardware)	190-2042
Scuff strips with rollers, complete set of control-end and loading end (ST70/MB70)	083-2192
Scuff strips with rollers, complete set of control-end and loading end (ST64/MB64)	083-2201
Scuff strip (no rollers), control-end leg only, w/hardware	190-2035
Scuff strips, loading-end leg brace only, (pair, w/hardware)	190-2045
Leg torsion spring (left/right), control-end leg (w/hardware)	190-2037
Return spring (only), loading-leg w/hardware	190-2041
Restraint, Harness Mondial MB	120-4016
Restraint, Model 430 2-piece, 1.5m [5']	031-3892
Restraint, Model 430 1-piece, 2.1m [7']	031-3910
Strike pin, control-end weldment	083-2254
Torsion springs, loading-end leg lock	190-2043
Control handle, leg-release (Red)	190-2049
Control handle, swivel-release paddle (Blue)	190-2051
Loading-wheel shank glider (pair)	190-2053
Swivel caster release pin and spring	190-2054
Control-box assembly (loading end or control end)	090-5919
Control-box assembly, center	090-5920
Control-end leg auto-release assy. w/spring	090-5921
Touch-up paint, green	082-2418
Touch-up paint, silver	082-2419
Touch-up paint, black	081-9977
Touch-up paint, red	081-9972
Pulley and extension spring (w/hardware)	090-5939

10 - ACCESSORIES

Ferno offers a full line of accessories approved for use with the cot. Follow all instructions in accessory users' manuals. Keep the instructions with this manual.

When using accessories, be aware of any special considerations such as doorway heights and widths, or other factors which may be affected by the addition of the accessory/accessories to the cot.

Contact Ferno Customer Relations (page 2) or your Ferno distributor for product information.



WARNING

Attaching improper items to the cot can cause injury. Use only Ferno-approved items on the cot.

Description	Accessory
FL1 Fastening System	057-3080
Mondial® Safety Lock Device	083-2164
Mondial® Safety Lock Device (tube-type)	083-2189
Mondial® Tracker™	083-2165
PediMate®	031-3778
Storage tray, Monobloc	083-2190
Telescoping handles, side, Monobloc	083-2191
Telescoping handles, end, Monobloc	083-2216
Restraint keeper, Monobloc	083-2260
EFX or Mondial® IV pole	083-2024
IV Pole for Mondial® Monobloc MB64, MB70	083-2197

